

ROCKO

Tiles by Kronospan



USER MANUAL #04/2023

ENGLISH VERSION



www.rocko-tiles.com

KRONOFLOORING Sp. z o. o.
Wojska Polskiego 3
39-300 Mielec Polska
www.rocko-vinyl.com
jaslo.sales@kronospan.pl
+48 134424901

ROCKO WATERPROOF WALLS

This document has been prepared for the needs of users and is a collection of information for the correct selection, storage and installation of the product. The guide applies to Rocko Tiles waterproof wall panels belonging to for the latest generation of SPC (Stone Plastic Composite) wallcoverings, for indoor domestic or commercial use. The Rocko Tiles core, made of over 70% natural marble, is finished with a decorative layer covered with high-quality UV varnishes. Thanks to the technologies used, the product has very high performance and quality parameters, which are presented in these instructions for use.



TABLE OF CONTENTS

• credentials	str. 3
• product properties	str. 4
• technical sheet	str. 5
• Rocko Tiles collection	str. 8
• delivery and packaging of the product	str. 12
• recommended accessories	str. 14
• dry area assembly	str. 16
• wet area assembly	str. 17
• use and care	str. 30

CREDENTIALS

The company Kronoflooring Sp. z o. o. has an implemented and certified Quality **ISO 9001:2015** (DNV GL certificate No: 277306-2018-AQ-POL-RvA).

In terms of **Corporate Social Responsibility (CSR)**, the company meets the requirements of the **SA8000** standard, working on the basis of the Kronospan Standard, and also meets the importer's safety requirements, in accordance with with the American **C-TPAT** standard.



REQUIREMENTS AND CREDENTIALS BY COUNTRY



- Requirements for construction products AqBB (EN16515 for VOC and formaldehyde emissions)
- MVV TB / ABG Annex 8
- German requirements for Blue Angel RAL-UZ



- Belgian VOC requirements



- French VOC requirements



- Austrian requirements for Eco Label UZ 56



- Finnish M1 classification



- British BREEAM requirements



- American requirements ASTM and LEED v.4
- FloorScore®

ROCKO TILES CHARACTERISTICS



Water resistance [ISO 24336] - the product is suitable for indoor use in dry and humid conditions, such as bathroom, laundry room, kitchen or vestibule.

According to the definition, waterproof is the term for a material that is fully water-resistant (water-resistant, seepage-resistant). Rocko Tiles manufactured in the SPC - Stone Plastic Composite technology are fully waterproof, therefore they can be successfully used in the kitchen, bathroom or laundry room.



Dimensional stability [ISO 23999] - the product does not change its dimensions under the influence of temperature and humidity changes, so it can be used in sunny and shaded places as well as in dry and humid places.

By definition, dimensional stability is the ability to retain its original dimensions when exposed to heat under certain conditions. Rocko Tiles guarantee a dimensional stability of 0.25% in the length and 0.25% in the width (according to ISO 23999 - Flexible floor coverings - Determination of dimensional stability and curl after exposure to heat). The tests were carried out for the maximum temperature value of +80°C.

Confirmation: EPH Certification Body - Test Certificate No. ST-19-06-11-02.



Fire resistance [EN 13501-1] - the panels meet the requirements of class C-s2, d0, so they are flame-retardant and emit moderate smoke.

European requirements apply the Euroclass system, dividing building materials in terms of reaction to fire into classes: A1, A2, B, C, D, E, F, along with additional criteria, taking into account smoke emission. On this basis, the risk of flashover, i.e. fire spreading explosively, can be assessed. The obtained class C defines the product as flame-retardant, symbol s2 - with average smoke emission, and d0 - no flaming droplets. The classification was carried out in accordance with EN 13501-1 Fire classification of construction products and building elements - Part 1: Classification based on reaction to fire tests, and tests in accordance with EN 13823 - Reaction to fire tests - Part 1: Determination of fire performance by radiant plate and EN ISO 11925-2 Reaction to fire tests - Ignitability of products exposed to direct flame

Confirmation: Certification Body of Sychta Laboratorium - Test Certificate No. SL / Z-472 / EN13501 / 717/2020.

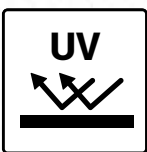

Light fastness [ISO 105-B02: 2014] - due to its parameters, the product can be used in highly sunny areas. The test is performed by controlled exposure to sunlight or artificial light generated by a xenon lamp.

Resistance is assessed on two scales:

- SkGrayscale with a range of 1-5, where 1 is the weakest and 5 is the highest fastness to light. This is due to the difference in shade between the irradiated product and the untested product. In the normative classification, the requirement is to meet the condition > 4.
- SBlue wool scale: lightfastness is awarded between 1-8. 1 - very poor, and 8 - excellent light fastness. Class 6 defines very good resistance to light, up to 100 years of normal use.

Confirmation: EPH Certification Body - Test Certificate No. ST-19-06-11-04.



Stain resistance [EN 438-2: 2019] - the top layer of Rocko floors meets the stain resistance requirements, incl. coffee, tea, alcoholic beverages or juices, cleaning agents used in kitchen, laundry, and care products used in the bathroom.

The test confirms the resistance to permanent staining. The samples are treated with many substances causing stains, to which the panels may be exposed in everyday use. Duration and contact conditions are specified for each substance. At the end of the specified exposure time, the substances are removed and the samples are tested for permanent traces on the surface. For food such as coffee, tea or milk, the test lasts 16 hours. For other substances, such as alcoholic beverages, hand cream, and chemical products such as acetic acid (30%), bleach, hair dyes, etc., an exposure time of 10 minutes is provided. Tests were performed in accordance with EN 438-2 High Pressure Decorative Laminates (HPL) - Thermosetting Resin Plates (commonly referred to as laminates) - Part 2: Determination of properties, obtaining the highest grade 5 (on a scale of 1-5), indicating no visible discoloration at the end of the test.

Confirmation: EPH Certification Body - Test Certificate No. ST-19-06-11-02.

DIMENSIONS

	thickness	4 mm · tmax - tmin ≤ 0,50 mm
dimensions	length	2800 mm
	width	1230 mm

SURFACE

Reaction to fire	EN 13501-1	C-s2,d0
Thermal resistance (conductivity)	EN 12667	0.008 (m ² K)/W
PU adhesion / Cross cut test [0-5]	EN ISO 2409	≤ 3
Scratch resistance - value	EN 438-2	5.5 N
Scratch resistance - class	EN 438-2	4
Gloss change	PN-EN 16094	A2
Abrasion resistance	EN 15468	3000 Cycles
Chemical resistance (e.g. acetone, alcohol, sodium hydroxide, hydrogen peroxide)	EN 438-2	5
Impact stability (large ball)	EN 438-2	1800 mm

MECHANICAL PROPERTIES

Dimensional stability - length	ISO 23999	≤ 0,25 %
Dimensional stability - width		≤ 0,25 %
Humidity exposure	Internal	No visual change or failure

AGEING

Changing temperatures test	Internal	OK
Light fastness (blue wool scale 6)	EN 13329	≥ 4

EMISSION

TUV PROFICERT LEVEL	Internal	Premium
AgBB		✓
A+		✓
Belgian VOC regulation		✓
MI1 Finnish classification		✓
Austrian Eco Label uz 56		✓

ENVIRONMENT

Content of phthalates	Free
Content of formaldehyde	Free
Hygienic certificate	Nr 396/322/403/2020

The data sheet is updated regularly to meet new technological standards.
This version replaces all previous versions as well as those which are undated.
This version takes effect upon creation. Version 01/2021

kronospan

Kronoflooring Sp. z o.o.,
38-200 Jasło, ul. Przemysłowa 10, Poland

ROCKO TILES RANGE

STONES



ORGANIC NEW COLLECTION

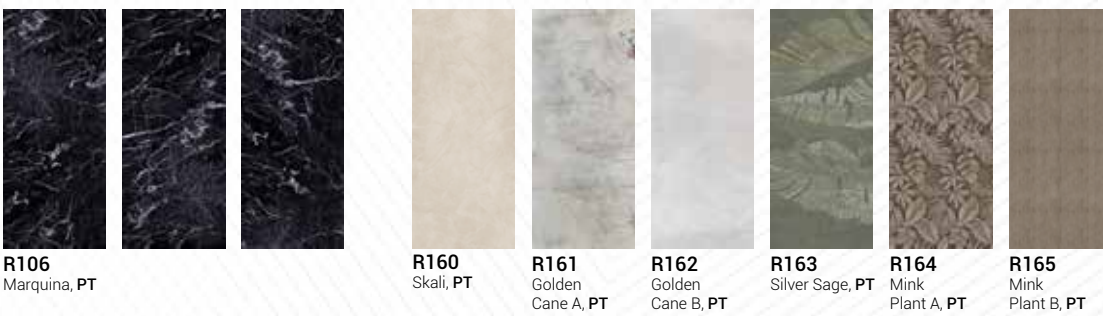

WOOD



METAL



COLOR

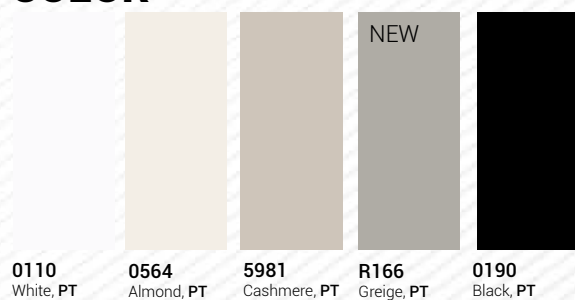

PRODUCT PACKAGING AND LOGISTIC DATA

Rocko Tiles are packed on wooden pallets, secured with foil, cardboard and PET straps. Each Rocko Tile is covered with a protective film that must be removed before product installation.

The boards are delivered as per with the following list:

FORMAT	m ² /pc	pc/pal	m ² /pal	kg/pal	pal/auto	m ² /truck	pal/con. 20'	m ² /con. 20'
2800 x 1230 x 4 mm	3,44	20	68,88	630	37	2549	22	1515

Label

Each panel is marked with a product label with decor name and EAN code.



For designs with three faces, each board has a label with corresponding face number.



Bulk packing

Rocko Tiles are packed on pallets marked with a label.

Each board on the bottom has a production batch code. One should use boards from same production batch for installation.

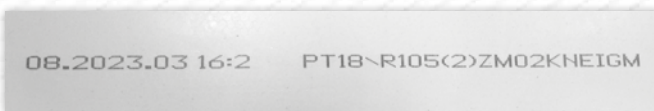

Shipping scheme
Auto 24 tons



Shipping scheme
Container 20'

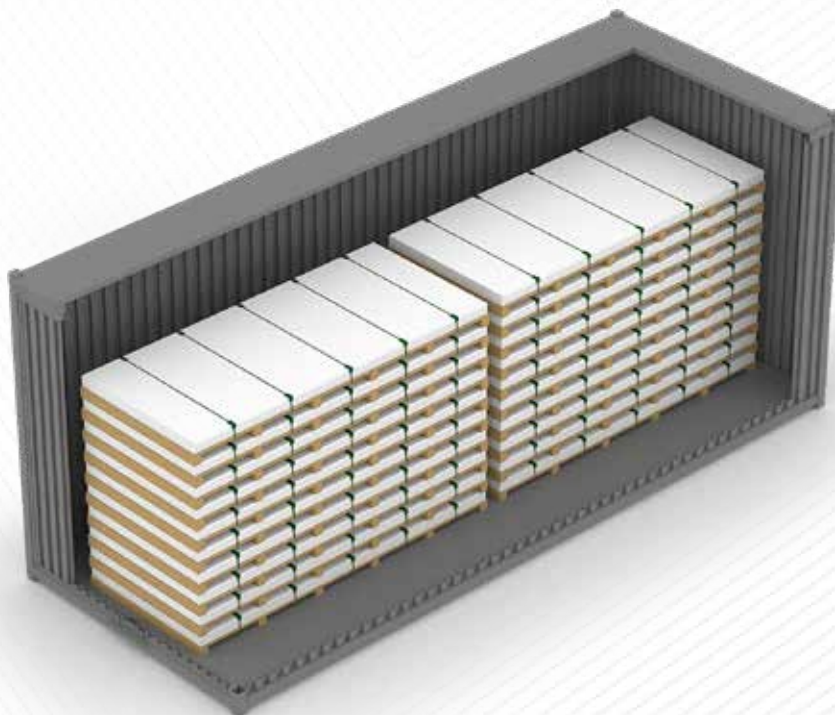

RECOMMENDED ACCESSORIES

Aluminum profiles

Anodized aluminum profiles for an aesthetic finish and durable protection of Rocko Tiles. They have increased corrosion resistance, so they will also work well in wet rooms. Available in five variants. Available in 2,800 mm length, in four basic colors: inox, platinum, black, white.

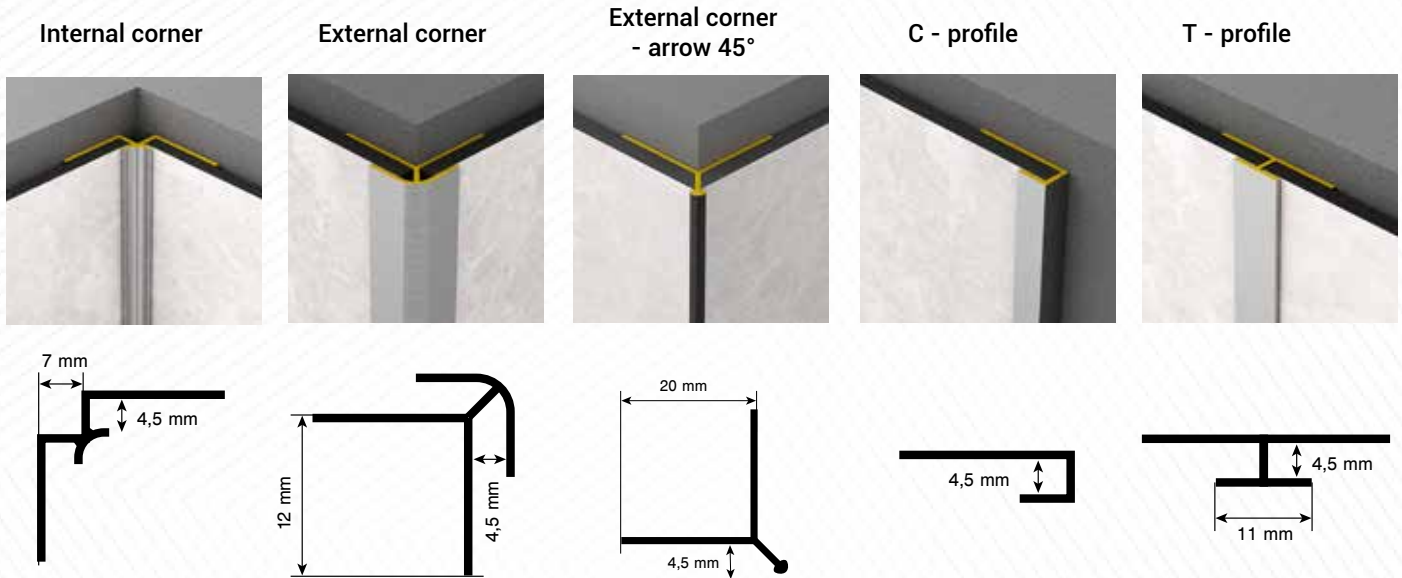

Adhesive

One-component, ready to use, flexible, solvent-free assembly adhesive and sealant. Has a very good adhesion to most materials and substrates used in construction works.

Available in 290 ml cartridges / 600ml in foil packages



Rocko Tiles cleaning agent

Rocko Tiles cleaning and maintenance agent that removes dirt and limescale. It does not damage the surface, does not leave a gray film and greasy residue.

Note: do not use any corrosive agents for cleaning, which can damage the surface of the plates.



Tile leveling system.



Matt Silicone, 300 ml cartridge

Available in colors: Grey, Black, Light Beige, Chocolate, White.



ROCKO TILES INSTALLATION

Rocko Tiles are designed for interior installation. The product is intended for finishing wall surfaces, both in dry and wet rooms. Correct assembly and maintenance will ensure long-term use of Rocko Tiles. The manufacturer is not liable for any damages related to incorrect installation or poor assembly conditions.

WASTE STORAGE	Order 10% more than the mounting surface to account for cuts and waste.
ACCLIMATION	48H
REQUIRED INSTALLATION CONDITIONS	15°C - 30°C [59°F - 86°F]
DEFINITION OF WATERPROOF	The structural integrity of Rocko will not be damaged when in contact with moisture / water.

INSTALLATION OF ROCKO TILES IN DRY ROOMS

1. ACCLIMATION

Prior to installation, Rocko Tiles must be acclimated to room temperature at the installation site. The room where product is to be installed must be between 15 ° C - 30 ° C [59 ° F - 86 ° F]. Rocko Tiles should be stored horizontally, on an even surface, under controlled environmental conditions.

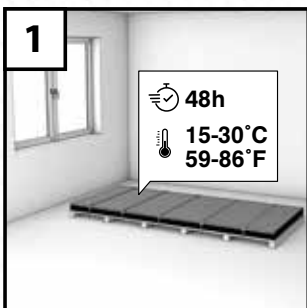

2. INSTALLATION TOOLS / RECOMMENDED ACCESSORIES

- Circular saw with guide bar
- Cutting disc - discs with a sufficiently large number of teeth are recommended, e.g. Ø 165mm (56 teeth) and Ø350mm (108 teeth)
- Universal knife
- Ruler, tape measure, pencil
- Distance crosses, clips for leveling tiles
- Glue float, cartridge squeezer
- Broom or vacuum cleaner
- Optional: table saw, hole saw, jigsaw, assembly gripper



3. SUBSTRATE PREPARATION

3.1 SUBSTRATE REQUIREMENTS

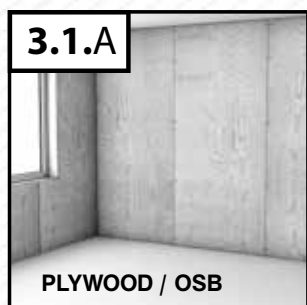

WOOD (PLYWOOD, OSB)

- Wooden substrates must be firmly attached to the base structure; Rocko Tiles should not be mounted on unstable, poorly attached subsurface
- The substrate must be load-bearing, dry, clean and degreased
- The substrate must be stable, free from cracks, bends and unevenness

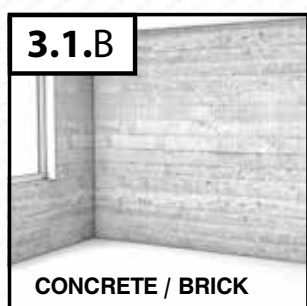

CONCRETE, BRICK

- Any unevenness of the substrate must be removed by grinding; dents or holes can be filled with a suitable putty and then primed
- The substrate must be hardened and seasoned according to with recommendations

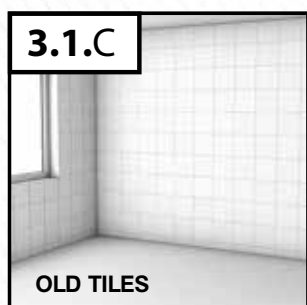

CERAMIC TILES, TERAZZO, STONE

- The existing substrate must be firmly attached to the substructure; do not mount Rocko Tiles to unstable, badly attached tiles
- The surface of the tiles must be thoroughly cleaned and degreased before applying the adhesive

3.2 SUBSURFACE LEVELING

The substrate must be leveled within max. 2mm by 1m in length [0.08 "by 40"]. No unevenness, deflection and faults.

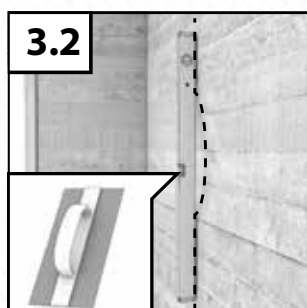

3.3 SUBSURFACE CLEANING

Clean the wall of dirt and dust and degrease it if you install it on a non-absorbent surface. The surface must be even and stable.

3.4. SURFACE DIMENSIONS

Before installation, measure the lengths of the walls on which Rocko Tiles will be installed. A properly planned layout prevents very narrow elements and allows keeping product proportions.

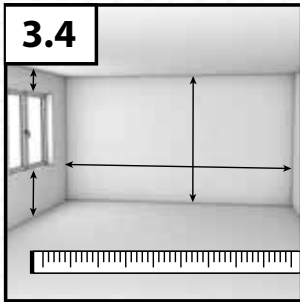

4. FORMATING ROCKO TILES

Format the boards with a circular saw with a guide. For cutting, we recommend using discs with a sufficiently large number of teeth, e.g. Ø165 mm (56 teeth) and Ø350 mm (108 teeth). Remember to cut the board with the decorative surface facing up. If there are electrical sockets or other installation components on the wall, cut holes in the board before its installation. Depending on the shape, holes can be cut with a hole saw or a jigsaw.

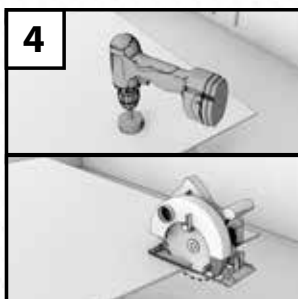

5. SURFACE CLEANING

Rocko Tiles must be cleaned. The bottom surface of the boards, on which glue is to be applied, must be free of dust, dry and degreased to ensure proper adhesion of the glue. Partially lift protective film on all sides of the board and check for damage or color difference.

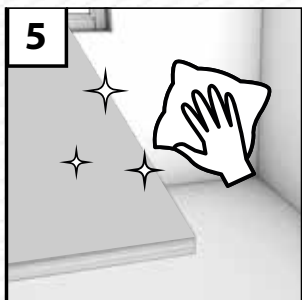

6. APPLICATION OF ADHESIVE FROM CARTRIDGE / FOIL PACKAGE

A. APPLICATION OF ADHESIVE

Apply the mounting adhesive to the bottom side of the panel or wall surface. If you are using glue in a cartridge or foil-package, apply it in vertical stripes at 10 cm intervals. Do not apply the glue in spots. Apply glue under the outline of each cut-out hole. The glued surfaces should be joined within 10 minutes of application of the adhesive.

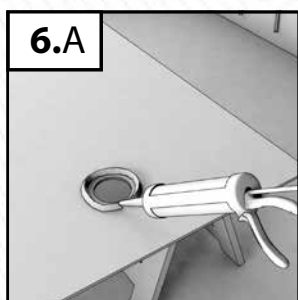
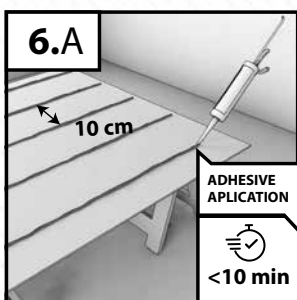
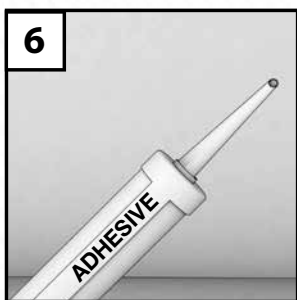

7. ADHESIVE APPLICATION WITH A TROWEL

Apply mounting adhesive to the bottom side of a panel or wall surface. Apply the glue to the entire surface of the board. Do not apply the glue in spots. The glue is applied with a trowel (C1) 4x4x4 mm. The glued surfaces should be joined within 40 minutes from the application of the adhesive.

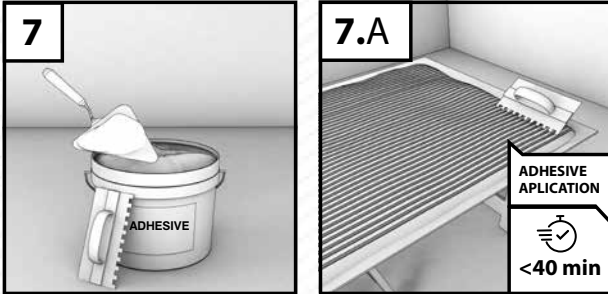

8. ADHERING OF PANELS TO THE SURFACE

After applying the glue, put the board against the wall and press it down. For optimal strength, press the board so that there is a ventilation gap of 2-3 mm between them. This distance will ensure that the adhesive joint is able to permanently transmit the deformation.

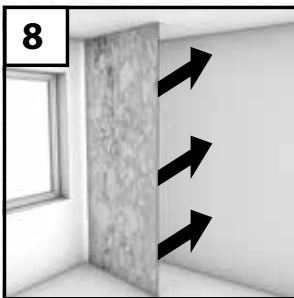

9. BOARD LEVELING

After first board installation, place the leveling clips - they will help achieving expansion gap between boards (2-3mm) and will facilitate the leveling of the surface. After sticking the next board, level the adjacent surfaces. Do not remove the leveling clips until the adhesive has set. Continue with the assembly of the next boards.



10. LEVELING CLIPS AND PROTECTIVE FILM REMOVAL

The adhesive setting time depends on the room temperature and air humidity (24-48 h). As the temperature and humidity level increase, the polymerization process speeds up. Provide effective ventilation until fully set. After work and adhesive setting completion, remove the leveling clips and protective film from the surface of the boards.

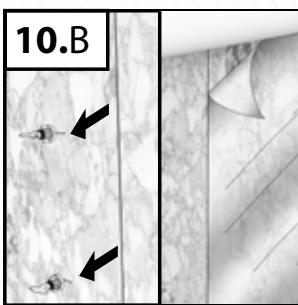
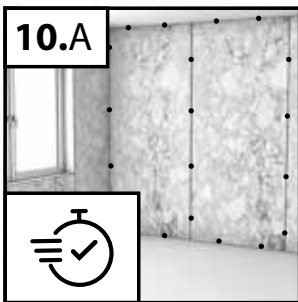

11. FILLING OUT THE JOINT

Expansion joints should be filled with a flexible joint (epoxy, silicone) or with dedicated finishing profiles (see page 7). Before applying the grout, protect the surfaces along the expansion joint with painter's tape - this will facilitate the grouting process and protect the surfaces from dirt. Profiles should be installed during the assembly of the boards. For profiles installation, use the same glue that you use for gluing the boards. During installation, fill the internal surfaces of the profiles with silicone in order to seal the profile-board connection.

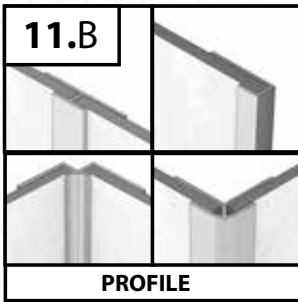
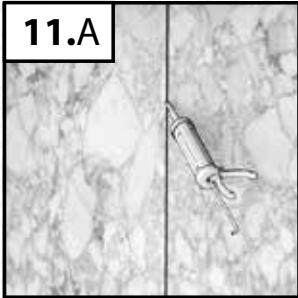

12. CLEANING THE PANELS AFTER ASSEMBLY

The Rocko Tiles surface can be used immediately after installation. Remove dust and dirt with Rocko Tiles cleaning fluid. Wipe the boards with a damp, not too fluffy cloth (preferably microfiber). Do not use wire or nylon sponges which can damage the surface.

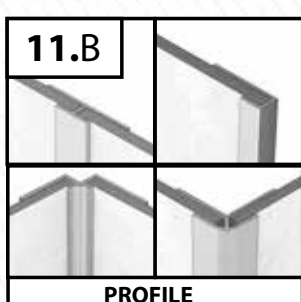
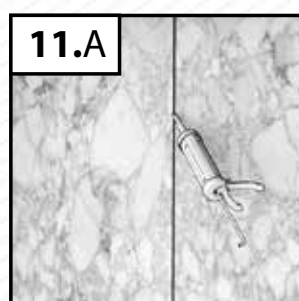
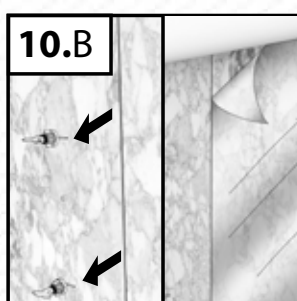
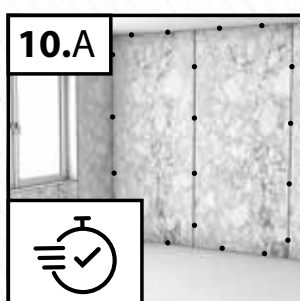
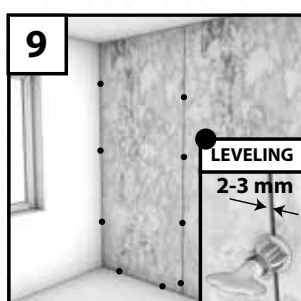
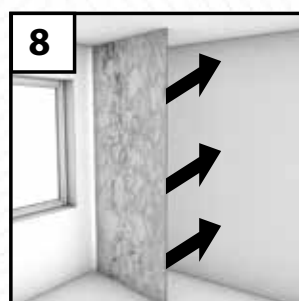
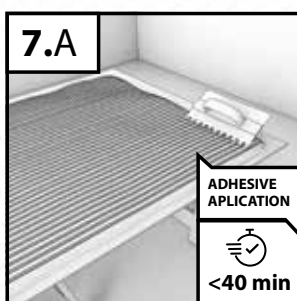
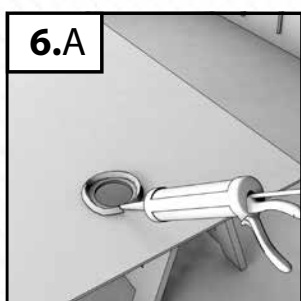
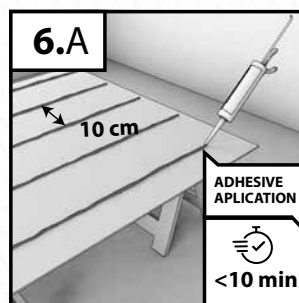
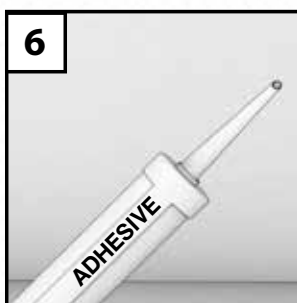
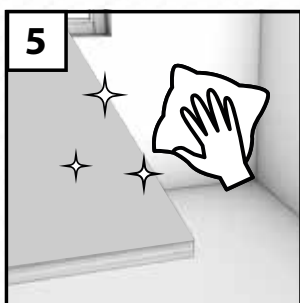
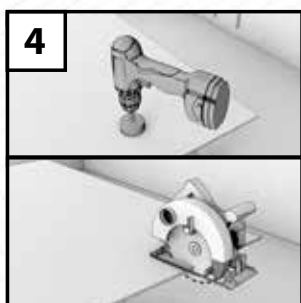
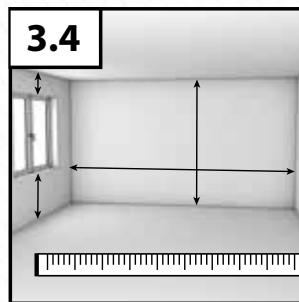
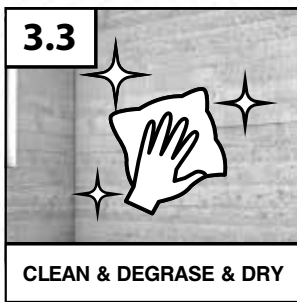
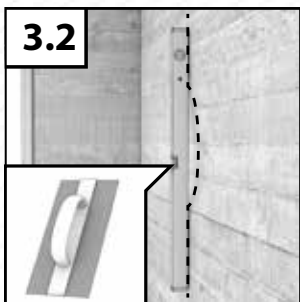
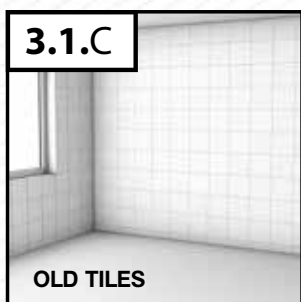
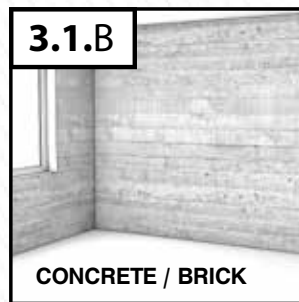
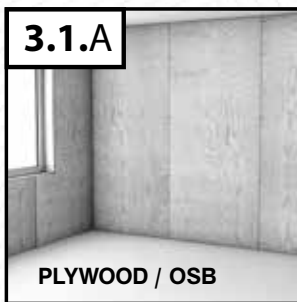
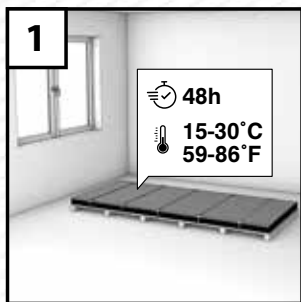

INSTALLATION OF ROCKO TILES IN WET ROOMS

1. ACCLIMATION

Prior to installation, Rocko Tiles must be acclimated to room temperature at the installation site. The room where product is to be installed must be between 15 ° C - 30 ° C [59 ° F - 86 ° F].

Rocko Tiles should be stored horizontally, on an even surface, under controlled environmental conditions.

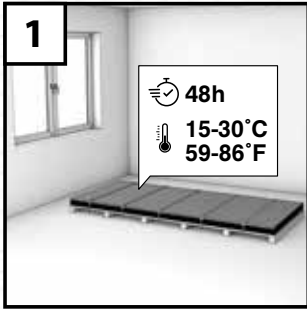

2. INSTALLATION TOOLS / RECOMMENDED ACCESSORIES

- Circular saw with guide bar
- Cutting disc - discs with a sufficiently large number of teeth are recommended, e.g. Ø 165mm (56 teeth) and Ø350mm (108 teeth)
- Universal knife
- Ruler, tape measure, pencil
- Distance crosses, clips for leveling tiles
- Glue float, cartridge squeezer
- Broom or vacuum cleaner
- Optional: table saw, hole saw, jigsaw, assembly gripper



3. SUBSTRATE PREPARATION

3.1 SUBSTRATE REQUIREMENTS

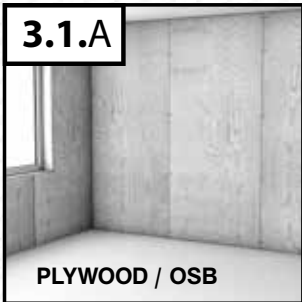

WOOD (PLYWOOD, OSB)

- Wooden substrates must be firmly attached to the base structure; Rocko Tiles should not be mounted on unstable, poorly attached subsurface
- The substrate must be load-bearing, dry, clean and degreased
- The substrate must be stable, free from cracks, bends and unevenness



CONCRETE, BRICK

- Any unevenness of the substrate must be removed by grinding; dents or holes can be filled with a suitable putty and then primed
- The substrate must be hardened and seasoned according to with recommendations



CERAMIC TILES, TERAZZO, STONE

- The existing substrate must be firmly attached to the substructure; do not mount Rocko Tiles to unstable, badly attached tiles
- The surface of the tiles must be thoroughly cleaned and degreased before applying the adhesive

3.2 SUBSURFACE LEVELING

The substrate must be leveled within max. 2mm by 1m in length [0.08" by 40"]. No unevenness, deflection and faults.

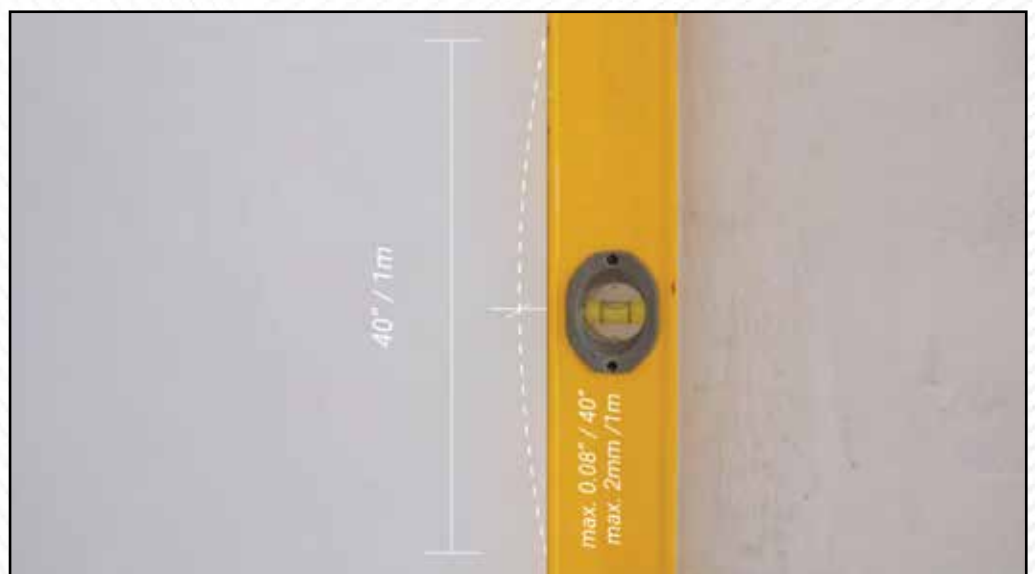
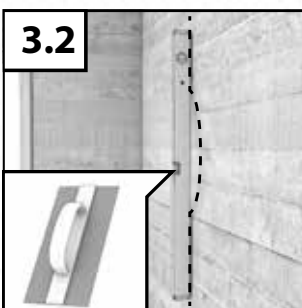

3.3 WATERPROOFING

Waterproofing, also known as anti-moisture and water-repellent insulation, protects room elements against destructive influence of water.

Shower walls should be insulated to a minimum height of 2.5 m, in the rest of the bathroom it is recommended to cover wet areas. In case of some materials, such as wood-based panels, cover completely surface with insulation, regardless of their application place.

Waterproofing can be done with a liquid foil or a sealing mat.



WATERPROOFING WITH LIQUID FOIL

Apply first layer of liquid foil to the surface with a roller or brush. Apply second layer when first is completely dry. Layer dries about 3 hours at 23°C. Boards can be installed after liquid foil is completely dry, i.e. after approx. 24 hours.

WATERPROOFING WITH SEALING MAT

- Start the work with applying a highly flexible C2 class adhesive to the substrate.
- Put the sealing mat on freshly applied layer of adhesive, then press and smooth from the center to the edge, so that there are no air voids under the mat. Sealing mat should overlap 5 cm.
- **WARNING:** the sealing mat must not be left as the final layer for more than 2 months.
- Corners and expansion joints should be sealed with a sealing tape, after shaping it slightly. Sealing should be done with a polymer glue-sealant.
- Seal internal and external corners by gluing in internal and external corner fittings.
- After the adhesive is cured (please follow manufacturer's recommendations), you can proceed to the next stages of Rocko Tiles assembly.



3.4. SURFACE DIMENSIONS

Before installation, measure the lengths of the walls on which Rocko Tiles will be installed. A properly planned layout prevents very narrow elements and allows keeping product proportions.

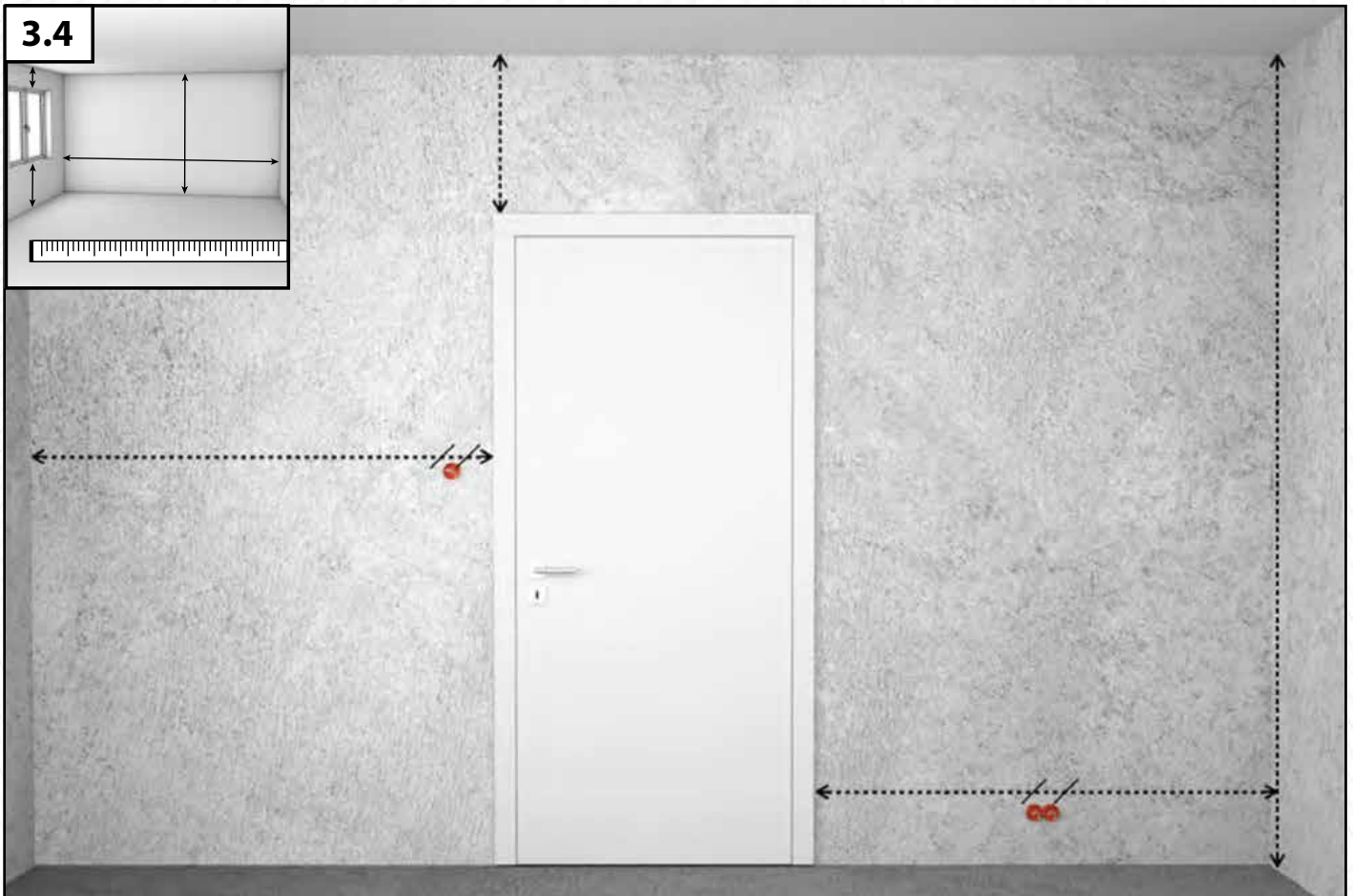

4. FORMATING ROCKO TILES

Format the boards with a circular saw with a guide. For cutting, we recommend using discs with a sufficiently large number of teeth, e.g. Ø165 mm (56 teeth) and Ø350 mm (108 teeth). Remember to cut the board with the decorative surface facing up. If there are electrical sockets or other installation components on the wall, cut holes in the board before its installation. Depending on the shape, holes can be cut with a hole saw or a jigsaw.

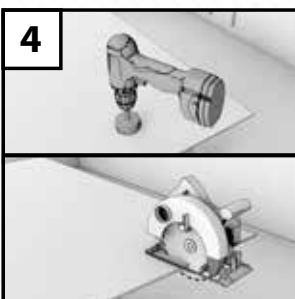

5. SURFACE CLEANING

Rocko Tiles must be cleaned. The bottom surface of the boards, on which glue is to be applied, must be free of dust, dry and degreased to ensure proper adhesion of the glue. Partially lift protective film on all sides of the board and check for damage or color difference.



6. APPLICATION OF ADHESIVE FROM CARTRIDGE / FOIL PACKAGE

A. APPLICATION OF ADHESIVE

Apply the mounting adhesive to the bottom side of the panel or wall surface. If you are using glue in a cartridge or foil-package, apply it in vertical stripes at 10 cm intervals. Do not apply the glue in spots. Apply glue under the outline of each cut-out hole. The glued surfaces should be joined within 10 minutes of application of the adhesive.

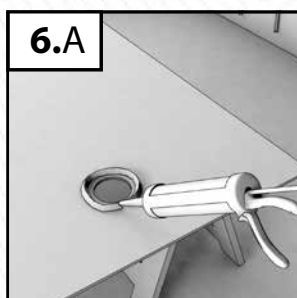
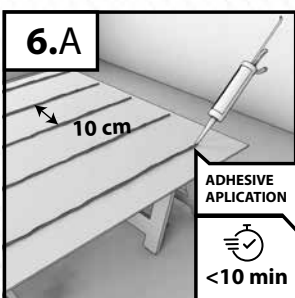
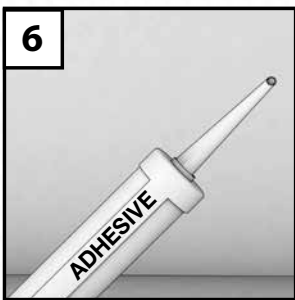

7. ADHESIVE APPLICATION WITH A TROWEL

Apply mounting adhesive to the bottom side of a panel or wall surface. Apply the glue to the entire surface of the board. Do not apply the glue in spots. The glue is applied with a trowel (C1) 4x4x4 mm. The glued surfaces should be joined within 40 minutes from the application of the adhesive.

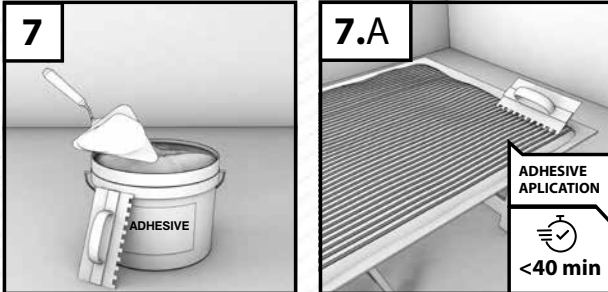

8. ADHERING OF PANELS TO THE SURFACE

After applying the glue, put the board against the wall and press it down. For optimal strength, press the board so that there is a ventilation gap of 2-3 mm between them. This distance will ensure that the adhesive joint is able to permanently transmit the deformation.



9. BOARD LEVELING

After first board installation, place the leveling clips - they will help achieving expansion gap between boards (2-3mm) and will facilitate the leveling of the surface. After sticking the next board, level the adjacent surfaces. Do not remove the leveling clips until the adhesive has set. Continue with the assembly of the next boards.

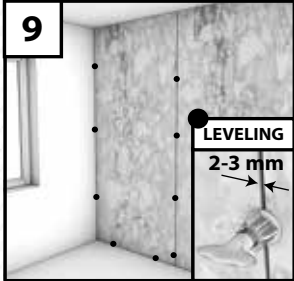

10. LEVELING CLIPS AND PROTECTIVE FILM REMOVAL

The adhesive setting time depends on the room temperature and air humidity (24-48 h). As the temperature and humidity level increase, the polymerization process speeds up. Provide effective ventilation until fully set. After work and adhesive setting completion, remove the leveling clips and protective film from the surface of the boards.

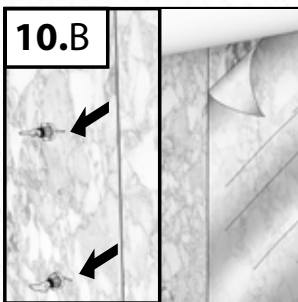
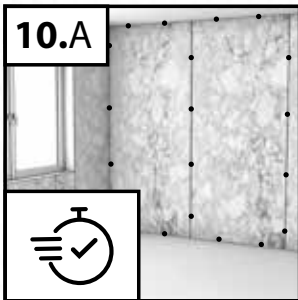

11. FILLING OUT THE JOINT

Expansion joints should be filled with a flexible joint (epoxy, silicone) or with dedicated finishing profiles (see page 7). Before applying the grout, protect the surfaces along the expansion joint with painter's tape - this will facilitate the grouting process and protect the surfaces from dirt. Profiles should be installed during the assembly of the boards. For profiles installation, use the same glue that you use for gluing the boards. During installation, fill the internal surfaces of the profiles with silicone in order to seal the profile-board connection.

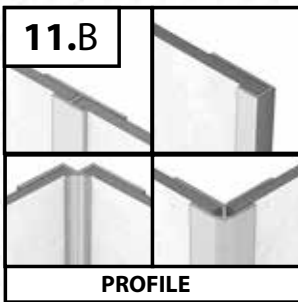
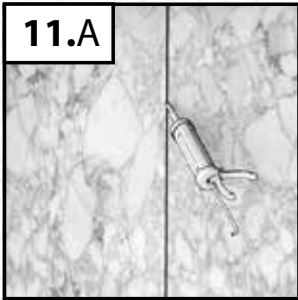

12. CLEANING THE PANELS AFTER ASSEMBLY

The Rocko Tiles surface can be used immediately after installation. Remove dust and dirt with Rocko Tiles cleaning fluid. Wipe the boards with a damp, not too fluffy cloth (preferably microfiber). Do not use wire or nylon sponges which can damage the surface.



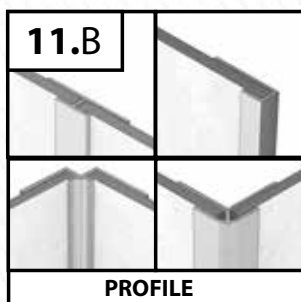
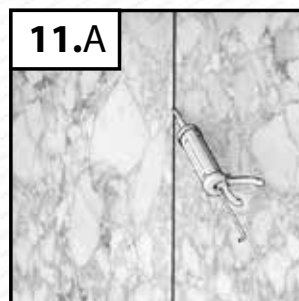
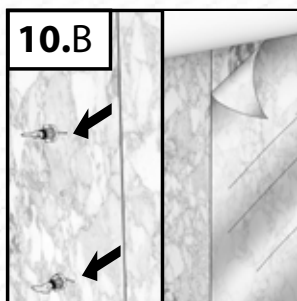
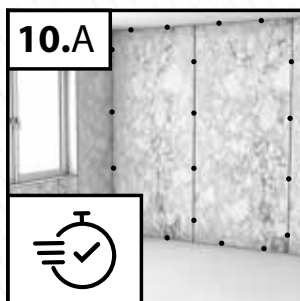
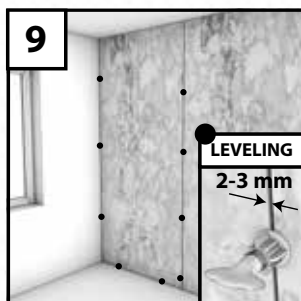
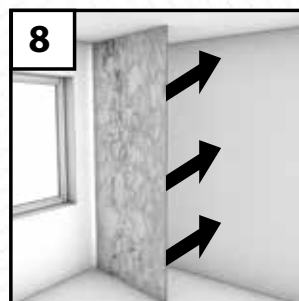
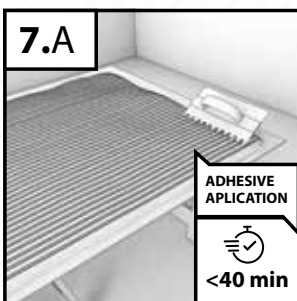
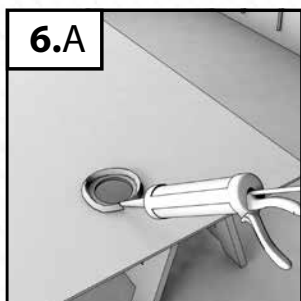
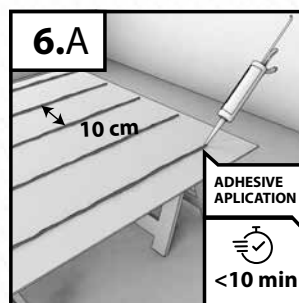
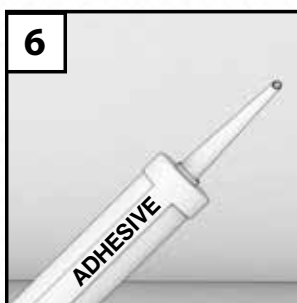
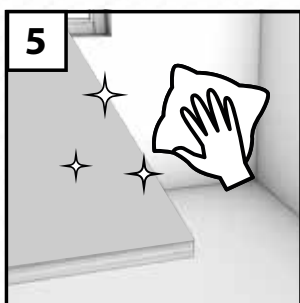
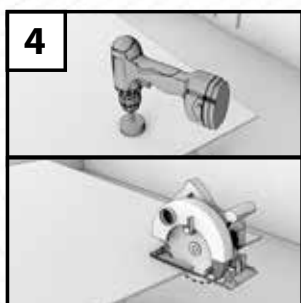
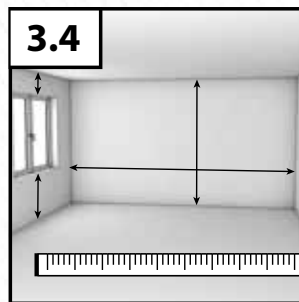
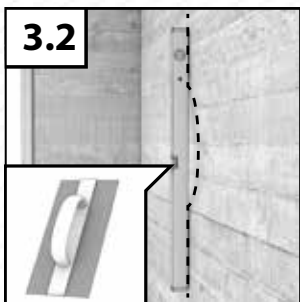
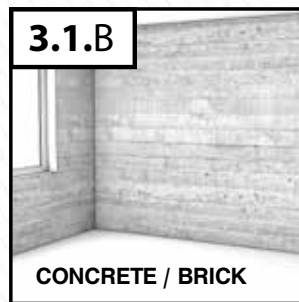
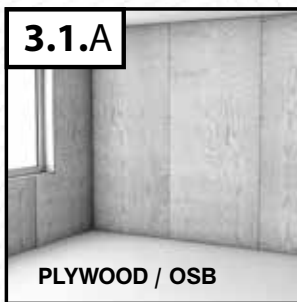
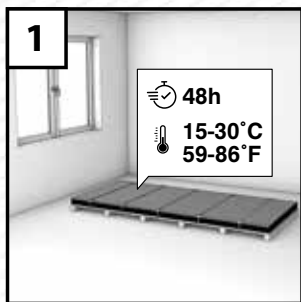

USE AND CARE

The Rocko Tiles surface can be used immediately after installation. Remove dust and dirt with Rocko Tiles cleaning fluid. Wipe the boards with a damp, not too fluffy cloth (preferably microfiber). Do not use wire or nylon sponges which can damage the surface.

Use only Rocko care and cleaning agents, as other aggressive cleaning agents can damage the surface. Do not use soap-based detergents, waxes or rinse aid as they can stick to the surface and leave unsightly streaks difficult to remove. Do not use abrasive cleaners or bleaches as they may scratch or dull the surface of the plates.

ROCKO

Tiles by Kronospan



www.rocko-tiles.com

04/2023/EN

Product information in this brochure is correct at time of publication. The company has a policy of continuous product development and reserves the right to change any product specifications given in this brochure. Due to the variations in the printing process, colours in this brochure may be subject to deviation from the actual products.



Distributor:

Kronoflooring Sp. z o.o.

39-300 Mielec

Producer:
Kronoflooring Sp. z o.o.

38-200 Jasło

ul. Przemysłowa 10

T +48 13 44 24 901

ul. Wojska Polskiego 3

T +48 17 58 22 200

F +48 17 58 22 300

sales.jaslo@kronospan.pl